

600 2000

()

2022 10

.....	1
.....	
.....	
.....	
.....	
.....	
.....	0
.....	1

1
-1

1

	00	000	
	10 - 0 00-0 -01-111		
	/		/
	11	.0	0.1
	1		- - 0 1
	/	/	/
	000		1.
%	.0		
		2	0 1
	010- 0 0	01	
		01 10	
	010- 0 0	01	
			010- 0 0 01

1.

(010- 0 0) (01)

(010- 0 0) (01)

2.

(010- 0 0) 01)

010- 0 0 01

	<p style="text-align: center;">1-1</p> <p style="text-align: center;">2010-2030 201</p>						
	<table border="1" style="width: 100%; height: 100%;"> <tr> <td data-bbox="459 331 1098 450"></td> <td data-bbox="1098 331 1294 450"></td> <td data-bbox="1294 331 1369 450"></td> </tr> <tr> <td data-bbox="459 450 1098 925"> <p style="text-align: center;">01 - 0 0</p> <p>1 . 1</p> </td> <td data-bbox="1098 450 1294 925"></td> <td data-bbox="1294 450 1369 925"></td> </tr> </table>				<p style="text-align: center;">01 - 0 0</p> <p>1 . 1</p>		
<p style="text-align: center;">01 - 0 0</p> <p>1 . 1</p>							
	<table border="1" style="width: 100%; height: 100%;"> <tr> <td data-bbox="459 925 1098 1440"> <p>()</p> <p style="text-align: center;">010- 0 0</p> <p style="text-align: center;">010- 0 0 01</p> </td> <td data-bbox="1098 925 1294 1440"></td> <td data-bbox="1294 925 1369 1440"></td> </tr> </table>	<p>()</p> <p style="text-align: center;">010- 0 0</p> <p style="text-align: center;">010- 0 0 01</p>					
<p>()</p> <p style="text-align: center;">010- 0 0</p> <p style="text-align: center;">010- 0 0 01</p>							
	<table border="1" style="width: 100%; height: 100%;"> <tr> <td data-bbox="459 1440 1098 1989"></td> <td data-bbox="1098 1440 1294 1989"></td> <td data-bbox="1294 1440 1369 1989"></td> </tr> </table>						

		+	

1.

00

000

(0 1)

2.

- 00

0 01

0 00

0 0 1

1-2

		1.		
-				

			1.		

		1.			
		0 0		1	
		0 0		1	
		1.			
			. 0 0		
				10	

			1.		
			1.		
				0 0	
				1 %	

	1.		
	.1 .1.1		
	.1.		
	. .1		
	. .		
	.		
	.1		
	/ 0	0 0	
	0.10	0.11	
	0 0	/	
	1.		

	<p style="text-align: center;">0 0</p> <p style="text-align: center;">.</p> <p>00 / 00 /</p>		
	<p>0 0 1</p> <p>0 0 1</p> <p>0 0 1</p> <p>1-4</p>		
	<p>1.</p> <p>.</p> <p>.</p>	<p>00</p> <p>000</p>	
	<p>1.</p> <p>1</p>		

	0		
	0		
00	00	0	

	. 1		
	100%		
	00		
	1.		
	.		
	.		

	<p>1. 1</p> <p>0 0 01 1 % 1 0 . % 1 . % 1 . % . %</p> <p>2. 1</p>		

	<p>0 0 0. 1. 1 .0 . 1 0. 1 0. 1 1. 0 1. 0. 0 0 1) .) . . 1 . 1 0. 0 0 / (</p>		
--	--	--	--

		+	
.			201 -2020
1-			201 -2020
	01 11		
1			
	/	001 1 0000 /	
	0%	0% +	

--	--	--	--

201

.

3

0. /

+

01

.

3 22 201

	.
	1
0%	1
+	0
	%
.	
	+
	0

	<p>10.</p> <p>11.</p> <p>12.</p>
--	---

	0 1
	-
	10
1	
	10

1.

00 000
()

000

00 000

2-1

1		00	
		000	

0 1 0 . 00

000

-

2-2

		1.	
		000	
		1 .	
		11 0	/
		0	/
		1 0	

				1 .
				1 .
			0	/
			0	0
			1 100	
				/
				/
				/
			1	0
		001		+
			1 0000 /	0
		00		+
			0000 /	1 1 .
				1
			1	.1
			1	.

2-3

1	1	
	1	
	1	
	1	
		10
10	1	0
11	1	1 0
1		00
1		
1	1	0 0
1	1	
1	1	000
1		
1 (1	
1	1	
0	1	

		00			
		1 + + 0 001	1 . . .1	1 0000 /	
			1 11. .1		
			1 11. .		
			1 . . .		

- -

- -

-

2-4

1			1 00		
			00		
			100		
			.	0	
			1 .0		
			.	0	
			. 1		
			1		

			0	
1			.	1 .
		/	0	
	/		1 00	
			0	
		/	1 000	

2-

1	- 0		00 -01-	0 %
				0 0%
			111- -	%
			1 1- -	%
			1 0%	
	- /		00 -01-	1 0%
				0%
			0- -	0. 1.0%
			111- -	%/ %
			1 1- -	%/ %
			0%/ 0- 0%	
			0 0%	
			0 0%	
-				

2-

1	- 0	100	1. 1. /	- -

	- /	100	.0- . 1.0 1. /	- -
	-	1.0 1.10 / 100		- / - - - - -

2-

	/		/	
	0	00	0	
	1 0	000		

2-

/ / / /

0 1. 1.0 0 0.1 % % .

0 1. . 0 1 . % % . .

0 1. 1 -

0 /

1

10 1

0

00

/ - 0 0 0

/

2-

				()	
1		0	/	0	
		/	/		
		/		1 .	
				.	/



/ M© 9Δ,, +X

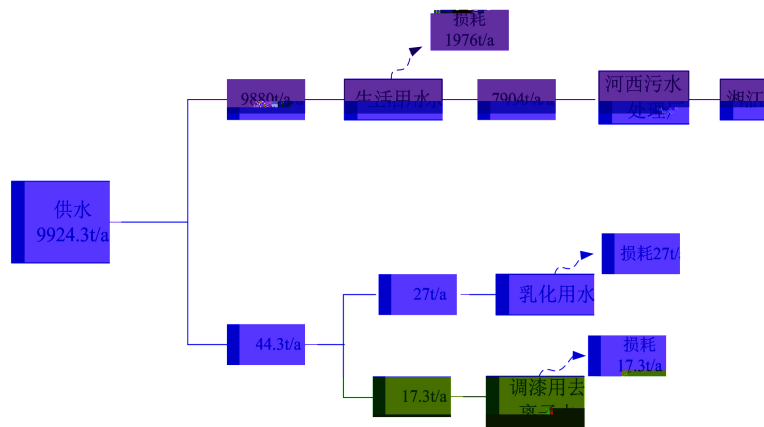

2-1

/

-10

2-10

		/	%)	/
1		.		.
		.	.	.
		1.		.
		1 1.	/	1 .

1 1.

1 . /

0%

+

1 0000 /

0%

%

. 0. / . /

1. 0. /

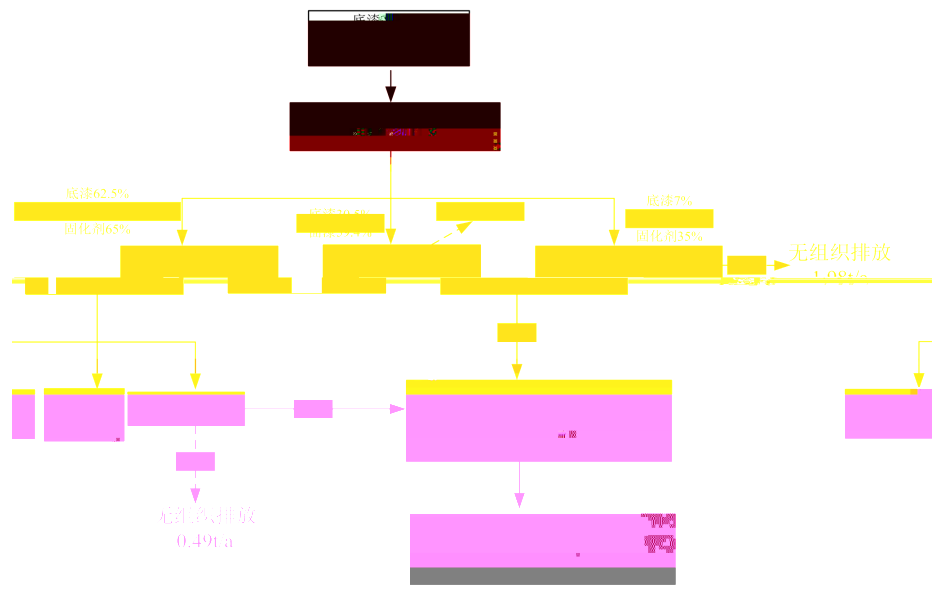

4.

000

1.

.0 %

2-11

		10	00	000
		0		1 0
	.			
		00	000	
	1			
	.			

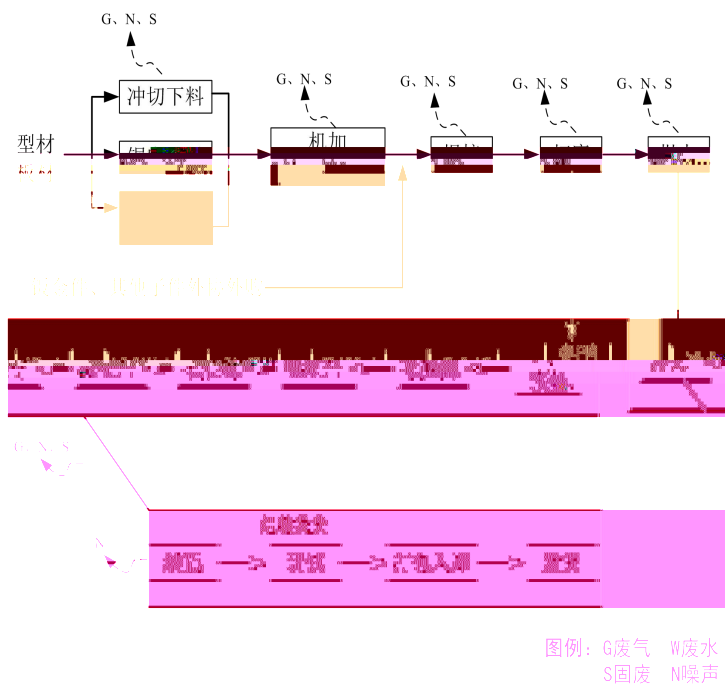

2-3

1.



+

0- 0

1 /

0-100 - /

1.

0 - 01

0 1 1-1

-1

3-1 2021

/ 3

/ 3

0 1 . %

0 0. 1%

0 . %

10

1.1 0%

1 □

3-2

1			1.	0 1

3-3

/ 3

		/ 3							/ 3
		0 1 .	0 1 .	0 1 .	0 1 .	0 1 .	0 1 .	0 1 .	
0		0. 1	0.1	0.	0.	0. 1	0.1	0.	0. 00
		0.1	0.	0.1	0. 0	0. 1	0. 1	0.1	0. 00

0 1

. - 01

0 - 01

2.

/0 - 00

- 00

()

0 1

3-4

/

() (/) (/)

0 1 ()

-

3-

		11 .	00	0	0 - 01
		11 . 1 1 0	1000	110	
		11 . 1 1	100	0	
		11 . 0	000	0	
				.	- 00
	0				
	00				

1.

-1

/ 1 - 01

1 1 - 00

3-

/

(-1)	00	00	00	*	-	0
(1 1 - 00)	10	10	0		-	0.

2.

1 -1

3-10

	()	()
	0	

4.

01

1 - 01

1 - 0 0

1 - 001

01

. /

1. /

0.0 /

0. /

. /

-1

1.

2.

3.

0 0

4.

1.

1

10 - 0 0 1

00 /

0

1.1 / -

. /

0%

%

. /

1.0 /

. /

. /

100 /

0

.1 / -

0. /

0%

%

0.1 /

0.0 /

0. 0.0 /

00 /

0

.1 / -

/

+

%

%

0000 /

000

0. 0. / . /

. . /

1

.

$$E_{\text{物料}} = \sum_{i=1}^n W_i \times WF_i$$

%

1 .

- -10

0%

1 0000 /

0%

%

. 0. / . /

1. 0. /

.

0%- 0%

0%- 0%

0%

0%

%

%

. %

. %

. %

. %

1 %

. /

. % 0. /

. /

. % . /

. 1 / . /

0%

0%

0. 0.1 /

0. /

0. 0.1 /

-1

	/	/	/	(/)	/	/
	1 .	.	0.	.	1.	0.
	. 1	0.	0.1	0.	0.	0.1

1 .

000

1

001

1

-

	1 . / -	. / -	0.0 / -	1 . / -
	1 . /	0.0 /	0.0 /	0. /
	/	0.0 /	0.0 /	0. /
		0.01 /	0.01 /	0.0 /

1 -1

1 -1

1 001 0 1 00 1 .

001 00

0

0 /

00

.0 /

%

0. 1 /

10 0 /

1 /

0%

/

1 - 001

0.0 /

4-3

/



			1 .	+	0%+	001 .	0.	.	1.	0.
			. 1		0%+	001 0.	0.1	0.	0.	0.1
			0.0		0	001 0.0	0.01	0.0	/	/
			0.0		0	001 0.0	0.01	0.0	/	/
			0.		0	001 0.	0.0	0.	/	/

-

4-4

1								
	001			11 .	.	0		10- 0
				0 1	0			
	00			11 .	.	1 .	1.	10- 0
				0 1				

0%

+

+ 0

-

0%

%

1 . /

%

. /

. /

. / +

1 . /

4-

1		* * 1 00 / /	0%
		1 - 00 / 00 / 0. / 0	%
		.1 1. .	

1

$$T = \frac{M \times S}{C \times 10^{-6} \times Q \times t}$$

%

%

»

□ »

□ » »

□

»

□

- 01

01 - 0 0

- 1 1

- 01

1 - 01

-

4-

001			/1 - 01 1
		1 /	1 -1
00		1 /	1 -1
		1 /	1 -1 /1 - 01
		1 /	- 01 .1

mpg

• 10.45.00
B

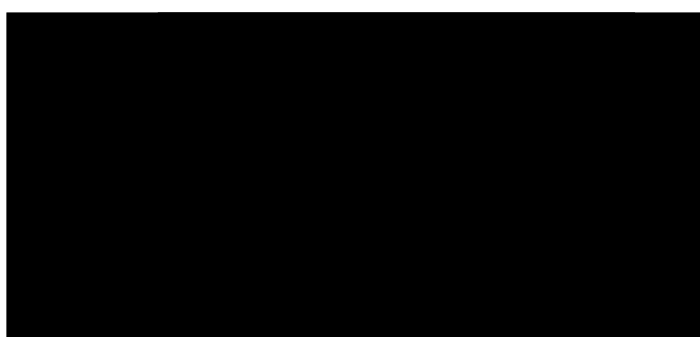

/																			
				/	/	/				/	/			/	/				
					0	.00					.10			0	0.0				
					.00	1.					0.			10	.00				0
						0.					0.0				.00				0
					10	1.		/			0.			10	.00				0
						0.					0.0			1	.001				0

-10

-11

4-

	()	()	()	()				()		
									()	
1					001			001		

4-10

				/						
				/						(/)
1	1 ⁰⁰	11 . 1100	.	0.			/			0
										10
										10
										1

4-11

1	001		-1	1 1 - 00

01

1 - 01

00 /

1

001 - 00

0 / 0
/

		1	/			.	.	0		0	0	1	
		1	/			.		.1		0	0	1	
			/			.	0.	.		0		1	
			/			.	.	.		0		1	
		1	/	0		-10.	-1.	.		0		1	
			/			.	-.	.		0		1	

4-13

			/						
							/		
							/		
							() / ()		
1	1	/	- .	- .	.	/	0		
		/	- 0	- .	.	/	0		
		/	- .	- .	.	/			
		/	-11 .	- .1	.	/			

1 - 00

-1

4-14

()

	/				()	()	
1	1 .	- .	.		.	0	
	1 .	- .	.		.		
	- .	-1 .	.		.		
	- .	-1 .	.		.		
	-1 .	-	1.		.1	0	
	-1 .	-	1.		.1		
	.	1	.		.	0	
	.	1	.		.		

0

1 - 00

1 - 00

01

1 - 01

-1

4-1

			1	/

4.

00 /

%

/

%

100 /

/

010

%

/

.0 /

0 /

1. /

0. /

1

11. /

. /

. / +

1 . /

1

0 1

00-0 -

. /

00 /

. 1 /

0. /

. 1 /

0 1

00-0 1-

. /

0 1

00- -1

0 .1

0. /

0. /

.1 /

. /

00-0 1-

1 - 001

0. /

0

00- -0

0. /

0

00- 1 -0

0. /

0 1

0 /

00-00 -0





/ /

0 0. /
 1 0 / /

-1

4-1

				/	/				
1				/		1	/		
				/		1	/		
				/		1	/		
				/	.0	1	/		
				/	1 .1	1	/		
				/	11.	1	/		
				/		1	/		

					
					
					
		/			

3

1 - 0 0

1 .

10^{-10} /

1.

()

(1 2.2-1)

1

(1 - 001)

4-1

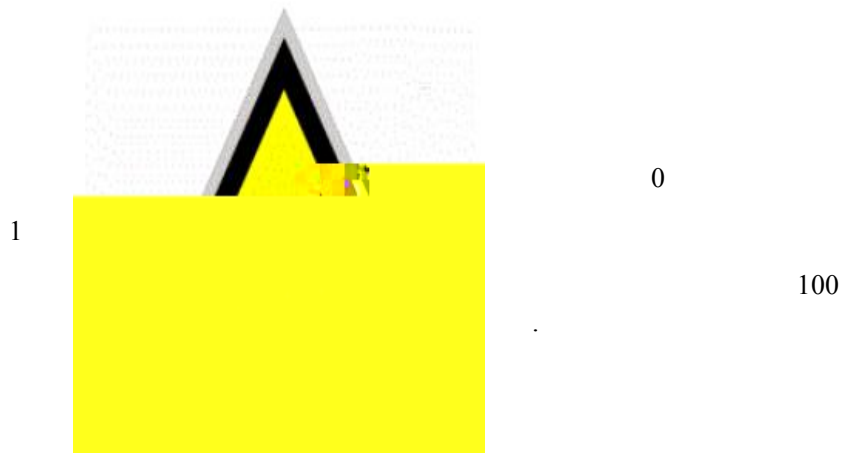



1.

1 0 .

(1)

100
()

()

()



0 0

		10 10	
--	---	-------	--

4-20

	/			
/				

4-21

<u>1</u>				+
		()		
		$1.0 \times 10^{-}$	$/$.0
				10^{-1}

4-22

1			0. 0.	0. /	100	100	0.00
---	--	--	-------	------	-----	-----	------

1 01

$$Q = \frac{q_1}{Q_1} + \frac{q_2}{Q_2} + \frac{q_3}{Q_3} + \dots + \frac{q_n}{Q_N}$$

1

1

1

1

1

1

10

10

100

100

4-23

	0.00	10			0.000
	0.	00			0.0000
	0.	00			0.000
	1	00			0.000
		00			0.001
					0.00

0.00 1

4-24

	000	00	
	11		0.1
	.0		

	1

0.00	1

.

+

001

1 0000 /

.

—

(
)'

	/
	1

		/	/	/	1.0 /	/	1.0 /	/
		/	/	/	. /	/	. /	/
		/	/	/	0.0 /	/	0.0 /	/
		/	/	/	0. /	/	0. /	/
		/	/	/	0 /	/	0 /	/
		/	/	/	0. /	/	0. /	/
	-	/	/	/	0.0 /	/	0.0 /	/
		/	/	/	. /	/	. /	/
		/	/	/	/	/	/	/
		/	/	/	. /	/	. /	/
		/	/	/	. /	/	. /	/
		/	/	/	. 1 /	/	. 1 /	/
		/	/	/	. /	/	. /	/
		/	/	/	. /	/	. /	/

		/	/	/	0. /	/	0. /	/
		/	/	/	0. /	/	0. /	/
		/	/	/	0. /	/	0. /	/